

Triebkopf 1

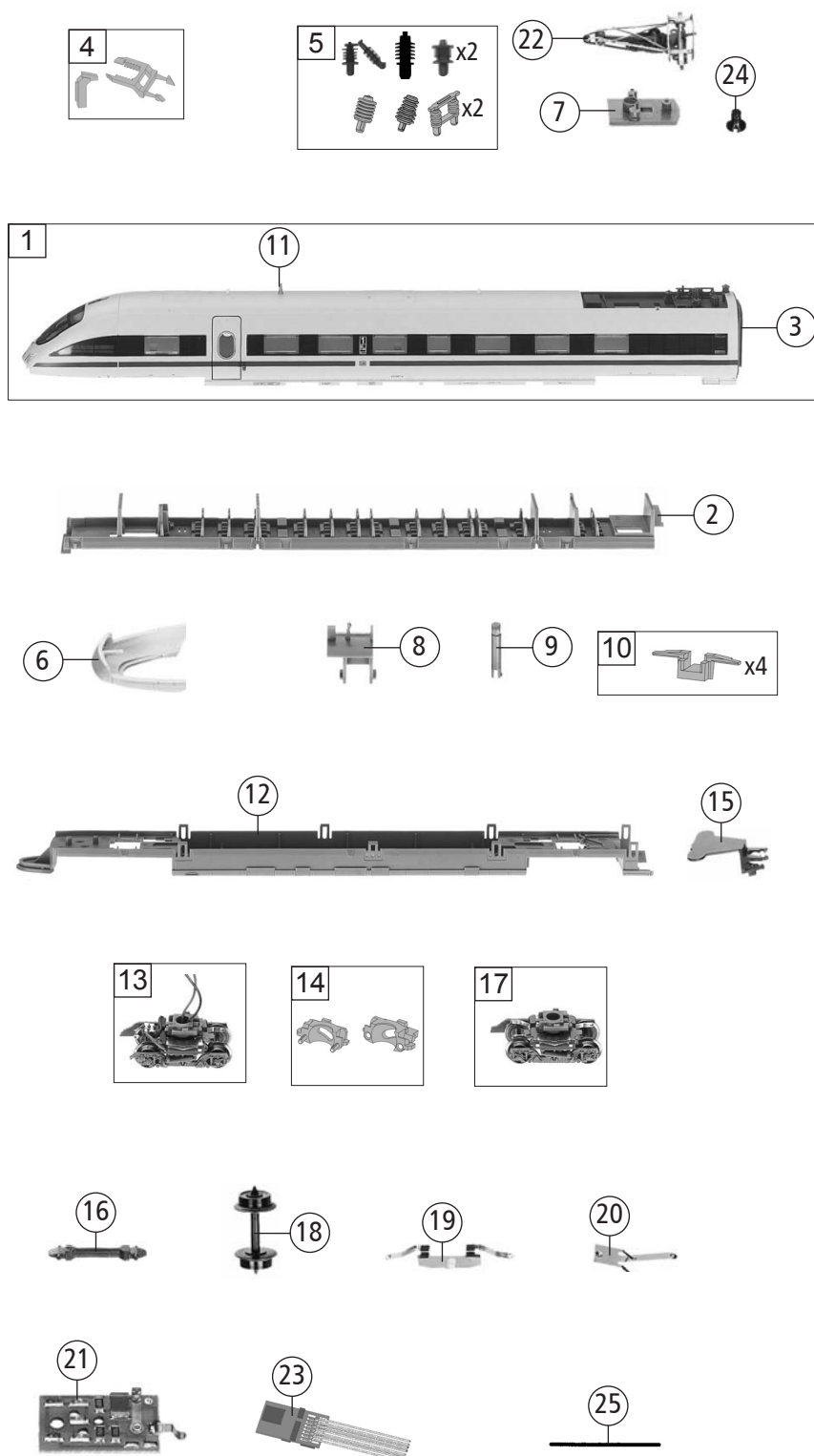

Pos. Nr. Pos.no.	Beschreibung Description	Art.-Nr. Art.no.	Preisgruppe Price bracket
746002	DB-AG ICE-T 411	=	N
746072		=	N
1	GEHÄUSE BETR. NR. 411 509-3 Body Loco. no. 411 509-3	107460021	33
2	INNENEINRICHTUNG Interior fittings	117460012	11
3	FALTENBALG Gangway	00128105	5
4	LICHTLEITER OBEN+UNTEN Light conductor upper+lower	13746002	8
5	TS - ISOLATOREN Part set - isolators	00147460	12
6	BUGSCHÜRZE Bug skirt	00157460	12
7	TRÄGERPLATTE F. PANTO. Carrier plate f. pantograph	00177460	7
8	SCHWENKTEIL F. PANTO. Pivotal part f. pantograph	00197460	7
9	RICHTTEIL Aligning part	01974601	7
10	TS - HALTETEIL Part set - Retaining part	01974602	11
11	ANTENNE LANG Antenna long	00197802	2
12	WAGENBODEN Floor	00307460	13
13	DREHGESTELL VORNE Bogie front	37746001	23
14	DREHGESTELLAUFNAHMEN Bogie reception	00387460	9
15	KUKU-DEICHSEL Short coupling reception	00388011	6
16	KUPPELSTANGE Coupling rod	00389005	9
17	DREHGESTELL HINTEN Bogie rear	39746001	19
18	RADSATZ KPL. N Wheelset complete	53715700	7
19	RADKONTAKT Wheel contact	00617913	2
20	KONTAKT BRÜCKE Contact bridge	00657066	1
21	SCHALTPLATTE Switch plate	65718500	20
22	EINHOLMSTROMABNEHMER Single arm pantograph	00677019	21
23	FUNKTIONSDECODER Function decoder	146696	30
24	SCHRAUBE M1,6x3 mm Screw	125023	3
25	RICHTFEDER F. DEICHSEL L=15 MM Straightening spring for bogie	00767008	1

Änderungen in Konstruktion und Ausführung vorbehalten
We reserve the right to change the construction and specification

Bordrestaurant mit Motor

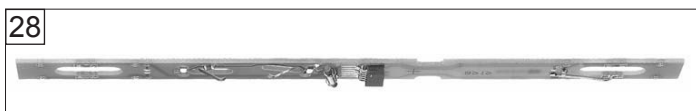
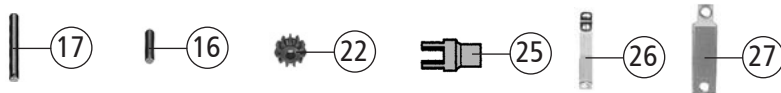
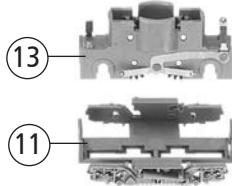
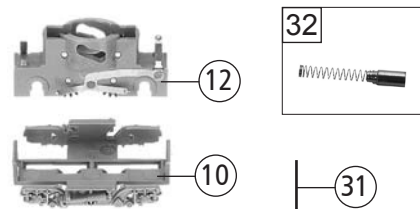
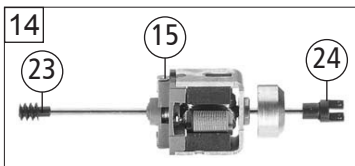
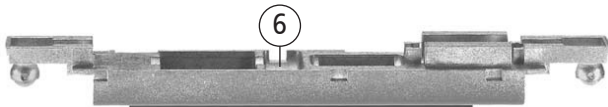
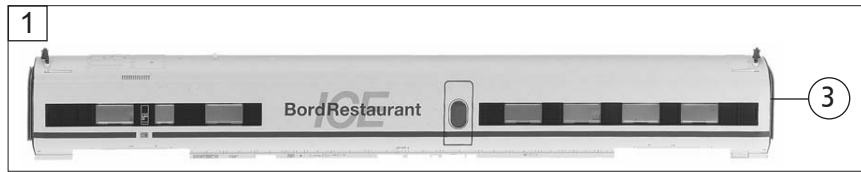
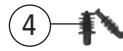

Pos. Nr. Pos.no.	Beschreibung Description	Art.-Nr. Art.no.	Preisgruppe Price bracket
746002	DB-AG ICE-T 411	=	N
746003		=	N
1	GEHÄUSE BETR. NR. 411 209-0 Body Loco. no. 411 209-0	107460022	33
2	INNENEINRICHTUNG Interior fittings	117460023	11
3	FALTENBALG Gangway	00128105	5
4	ISOLATOR Isolator	00147461	2
5	WAGENBODEN Floor	03074602	11
6	GRUNDRAHMEN Base frame	407460022	22
7	DEICHSEL Coupling reception	00388012	6
8	DEICHSEL Coupling reception	00388013	6
9	KUPPELSTANGE Coupling rod	00389005	9
10	DREHGESTELLRAHMEN 1 Bogie framework	00317460	11
11	DREHGESTELLRAHMEN 2 Bogie framework	00417460	11
12	DREHGESTELL BLOCK 1 Bogie block	00457460	19
13	DREHGESTELL BLOCK 2 Bogie block	00467460	19
14	MOTOR M. SCHWUNGMASSE Motor with flywheel	00507460	29
15	KOHLEHLATER Carbon brush holder	00507801	1
16	ACHSE L=6,4 D=1,5 Axle	00527004	1
17	ACHSE L=14 D=1,5 mm Axle	00527006	1
18	ANTRIEBACHSE Drive axle	00527460	17
19	RADSATZ. M. ZAHNRAD M.NUT Wheelset with gear wheel with groove	00537070	12
20	RADSATZ. M. ZAHNRAD O.NUT Wheelset with gear wheel w/o groove	00537071	12
21	HAFTREIFEN Traction tyre	00547005	1
22	ZAHNRAD Z: 11 Gearwheel	00567150	6
23	SCHNECKE Wormgear	00567612	5
24	KARDANSCHALLE F. MOTOR Cardan reception f. motor	00567613	3
25	KARDANSCHALLE Cardan reception	00567614	3
26	KONTAKTBÜGEL Contact plate	00657062	1
27	PLATINE UNTEN PCB lower	00657063	14
28	PLATINE PCB	65718600	26
29	BLINDSTECKER Dummy plug	00667101	13
30	SCHRAUBE M1,6x3 mm Screw	125023	3
31	RICHTFEDER F. DEICHSEL Straightening spring f. bogie	00767010	1
32	KOHLEBÜRSTE + FEDER Carbon brush + spring	133936	6
33	ACHSE L=6 mm D=1 mm Axle	00527009	1
Sound			
34	LAUTSPRECHER FOX Loudspeaker	68701100	16
35	SOUNDDECODER Sound decoder	146695	40

Triebkopf 1

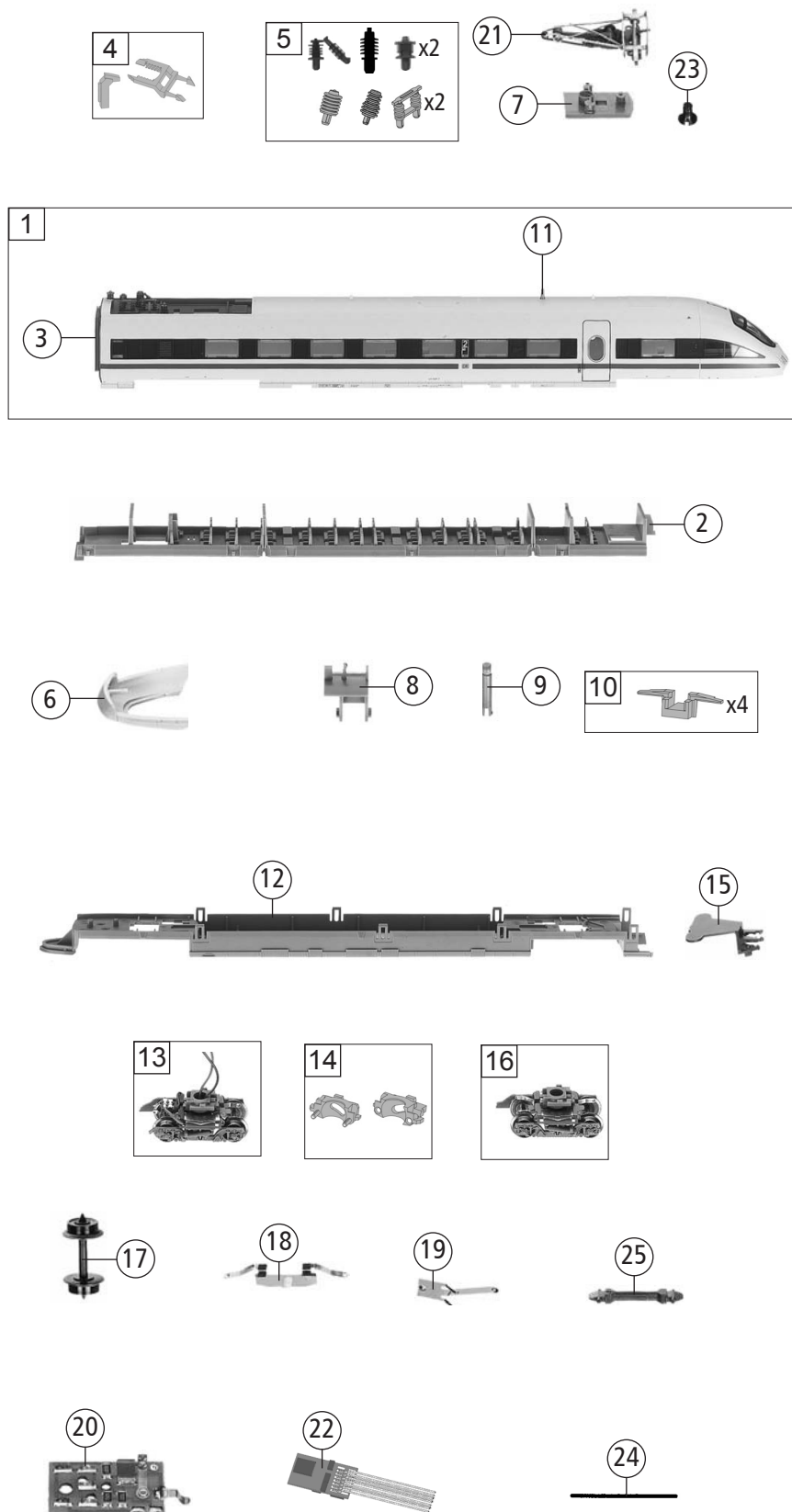

Pos. Nr. Pos.no.	Beschreibung Description	Art.-Nr. Art.no.	Preisgruppe Price bracket
746002	DB-AG ICE-T 411	=	N
746003		=	N
1	GEHÄUSE BETR. NR. 411 509-3 Body Loco. no. 411 509-3	107460023	33
2	INNENEINRICHTUNG Interior fittings	117460012	11
3	FALTENBALG Gangway	00128105	5
4	LICHTLEITER OBEN+UNTEN Light conductor upper+lower	13746002	8
5	TS - ISOLATOREN Part set - isolators	00147460	12
6	BUGSCHÜRZE Bug skirt	00157460	12
7	TRÄGERPLATTE F. PANTO. Carrier plate f. pantograph	00177460	7
8	SCHWENKTEIL F. PANTO. Pivotal part f. pantograph	00197460	7
9	RICHTTEIL Aligning part	01974601	7
10	TS - HALTETEIL Part set - Retaining part	01974602	11
11	ANTENNE LANG Antenna long	00197802	2
12	WAGENBODEN Floor	03074601	13
13	DREHGESTELL VORNE Bogie front	37746001	23
14	DREHGESTELLAUFNAHMEN Bogie reception	00387460	9
15	KUKU-DEICHSEL Short coupling reception	00388010	6
16	DREHGESTELL HINTEN Bogie rear	39746001	19
17	RADSATZ KPL. N Wheelset complete	53715700	7
18	RADKONTAKT Wheel contact	00617913	2
19	KONTAKT BRÜCKE Contact bridge	00657066	1
20	SCHALTPLATTE Switch plate	65718500	20
21	EINHOLMSTROMABNEHMER Single arm pantograph	00677019	21
22	FUNKTIONSDECODER Function decoder	146696	30
23	SCHRAUBE M1,6x3 mm Screw	125023	3
24	RICHTFEDER F. DEICHSEL L=15 MM Straightening spring for bogie	00767008	1
25	KUPPELSTANGE Coupling rod	00389005	9